

## INSTALLATION AND CARE GUIDE SINGLE HANDLE LAVATORY FAUCET

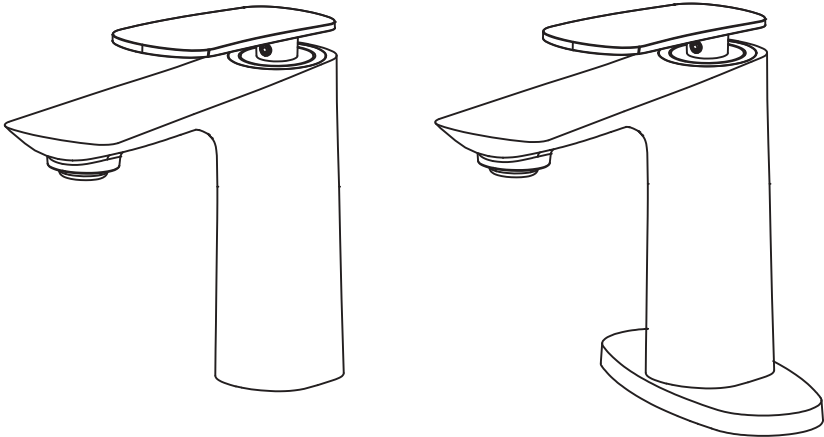

---

**Thank You**

**We recommend our products be installed by a professional.**

We appreciate the trust and confidence you have placed in our OAKLAND products. We strive to continuously create quality products designed to enhance your home at an affordable price. Please visit our distributor's website to see our full line of products available for your home improvement needs.

[WWW.SINKAUTHORITY.COM](http://WWW.SINKAUTHORITY.COM)

## Helpful Tools

### Tools:

Gather the necessary tools as shown below to complete the installation of the faucet.



Plumber's Putty



Flashlight



Basin Wrench



Safety Glasses



Screwdriver



Pliers



Channel Locks



Adjustable Wrench

## Pre-Installation

1. CAUTION: Always shut off the water supply before removing/replacing a faucet.
2. Remove the mounting nut, rubber, and metal washer from the bottom (shank) of the faucet as shown in the diagram below.

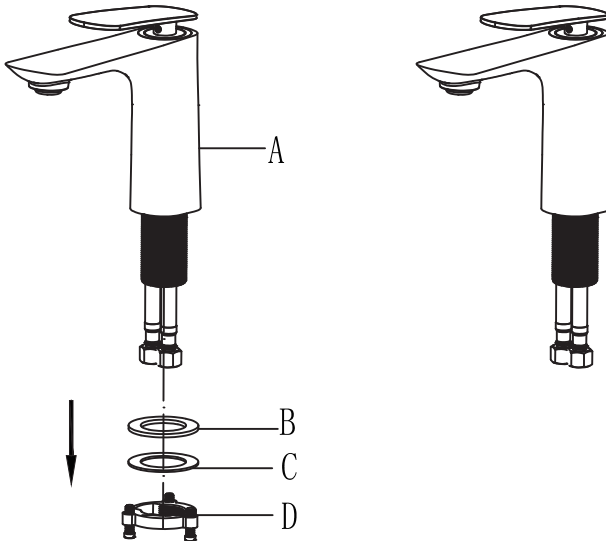

## Installation

### Installing the faucet assembly:

3. Insert the faucet body through the precut granite/marble/sink hole. The mounting hardware is installed from under the sink.

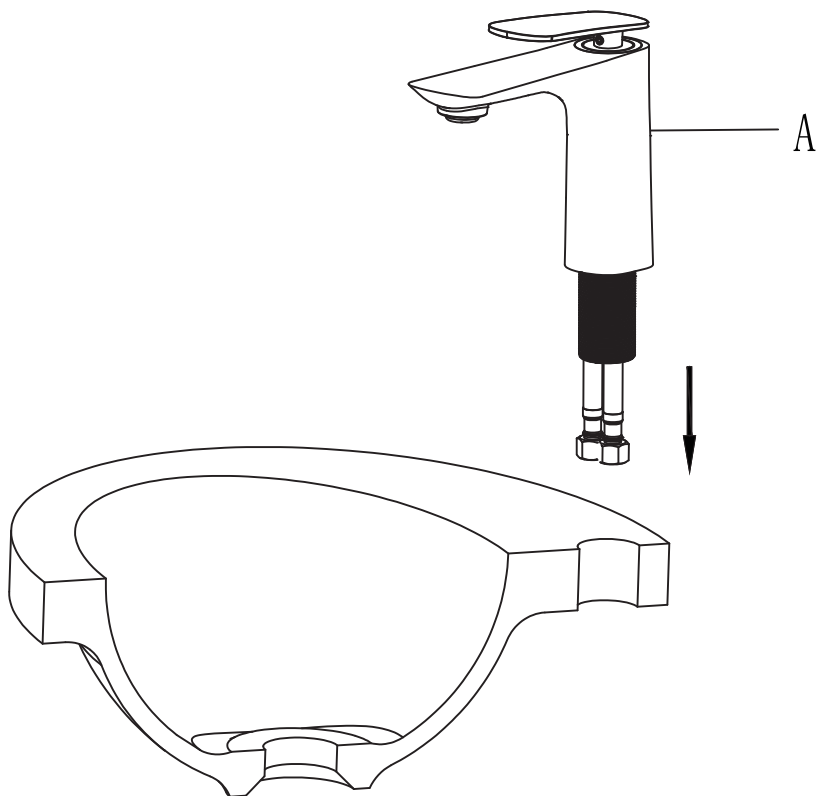

## Installation

### 4: Securing faucet to cutout:

From underneath the sink, secure the faucet assembly to the sink with the mounting nut rubber (B) and metal washer (C). Use a screw driver to tighten the screws on the metal nut (D).

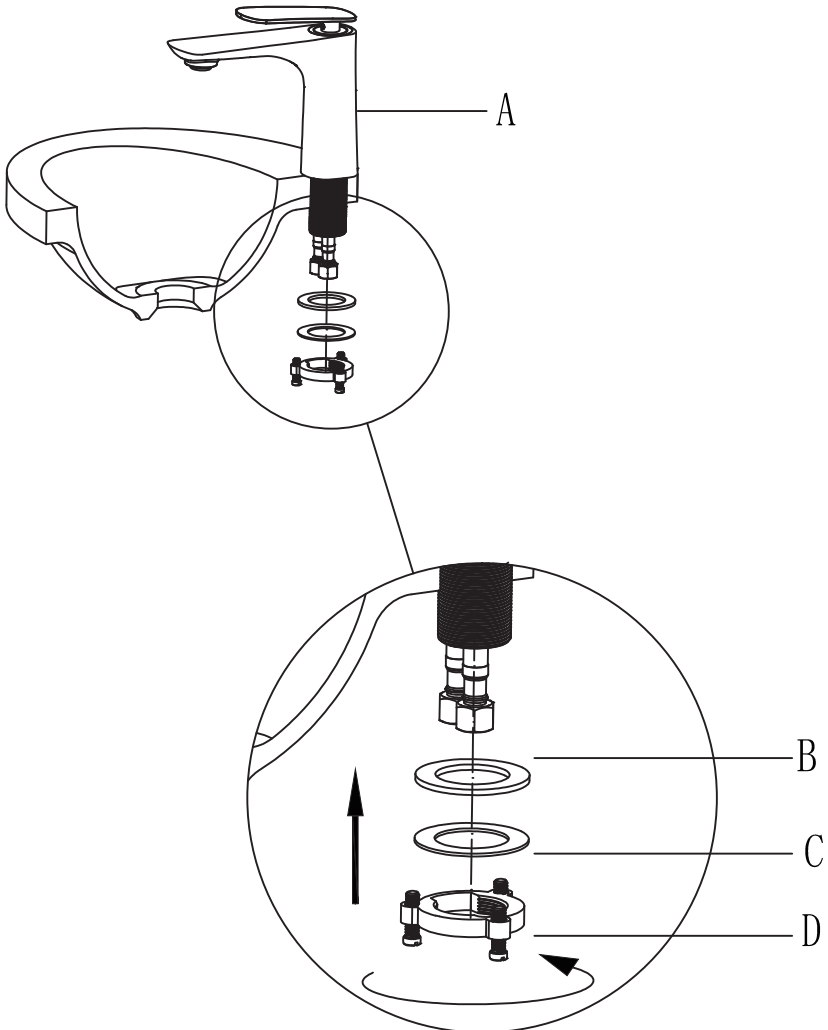

## Installation

### 5: Pop-up Drain Installation

1. Disassemble the Pop-up drain. Remove the lock nut and the bottom rubber washer.

2. Insert the drain body in the drain hole of the sink.

3. Slide bottom rubber washer back on drain body against bottom of sink. Tighten gasket and lock nut firmly against base for tight seal. Connect the drain Pipe to drain body.

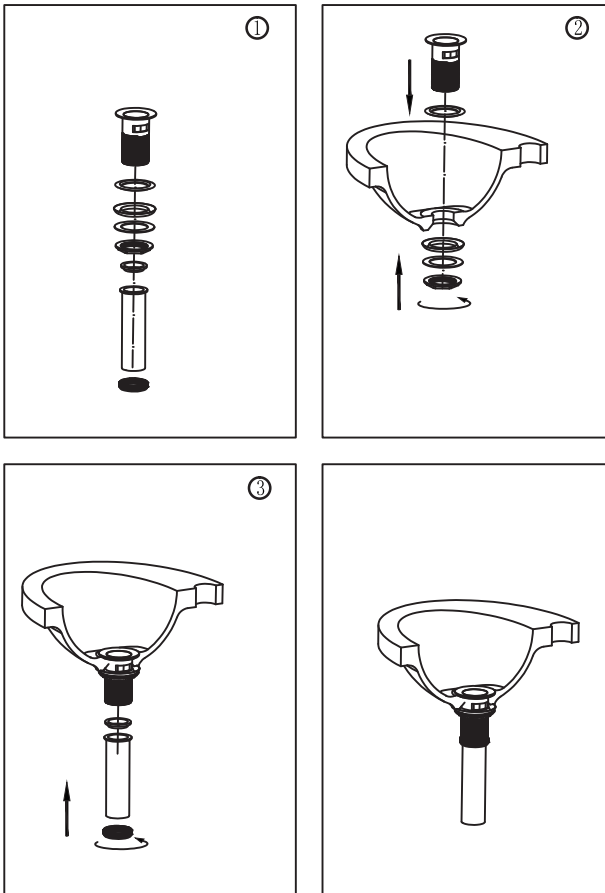

## Installation

### 6: Making the water supply connection

Thread the nut on the water supply line (1) into the outlet of the water supply valve (2) and tighten with a wrench. **DO NOT** overtighten. Note: the hot and cold supply lines are indicated by red (hot) and blue (cold).

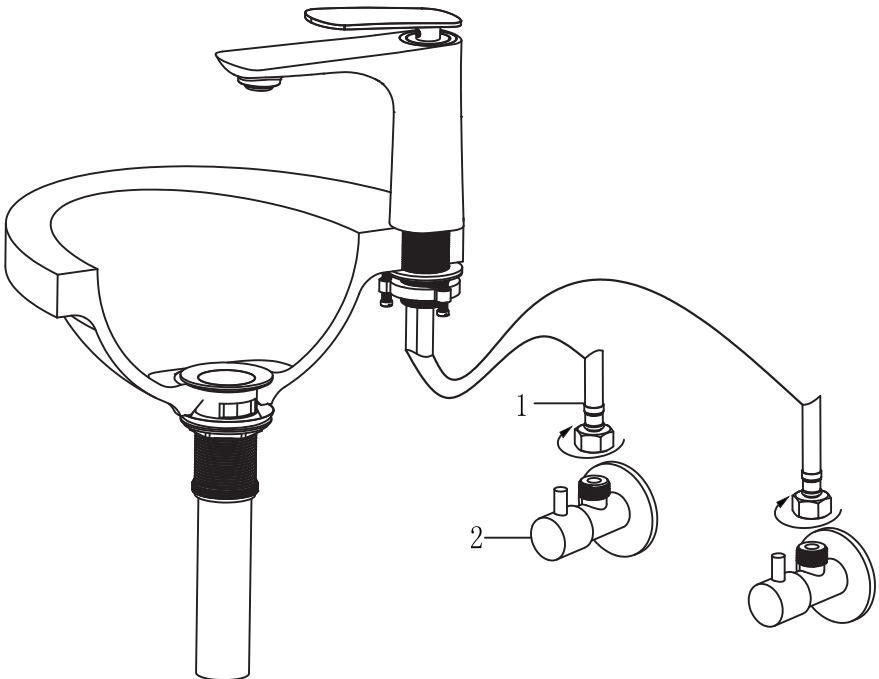

## Operation

### Flushing and checking for leaks:

- A. Turn on the water supply and check that the faucet is operating properly and that no leakage is detected from any of its parts. Also check underneath the sink to ensure all connections are secure and that there are no leaks.
- B. Pull the handle upwards to turn on the water.
- C. Position it to the left for hotter water and to the right for colder water. To turn off the water, push the handle down.

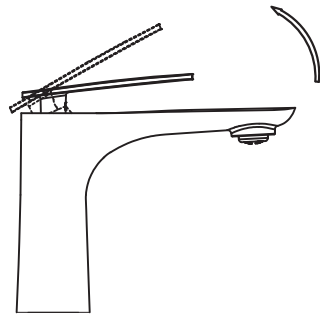
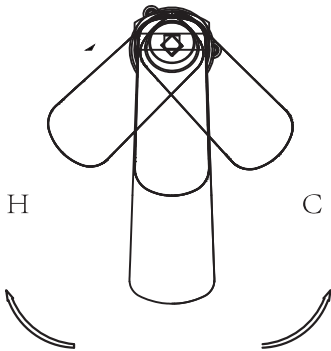

### Care and Cleaning:

To clean the faucet, wipe down with a damp cloth and then with a dry towel. DO NOT use abrasive cleaners, steel wool, or harsh chemicals when cleaning the faucet, or the warranty will be voided.

**SPECIFICATIONS**

Model No.: KSB1106

**SINGLE HANDLE LAVATORY FAUCET**

**Description**

- Single Hole Installation
- Metal construction with various finishes
- Flexible supply line with PEX inner hose and 3/8" compression nut
- Matching Finish Pop-up Drain Included
- Single handle operation makes precise and convenient control
- Optional deck plate (upon separately purchase) for 3 hole installation
- 100% Pressure System Tested

**Operation**

Lever style handle

Temperature controlled by 100° arc of handle travel

**Flow**

Flow is up to 2.2gpm (8.3L/min)

**Cartridge**

Premium grade ceramic disc cartridge

**Standards**

 Third party certified IAPMO, ASME112.18.1/CAS B-125-.1cUPC

 Certified to NSF/ANSI 61/9 & 372

 Complies with Federal LeadFreePlumbing Law and code AB1953

